

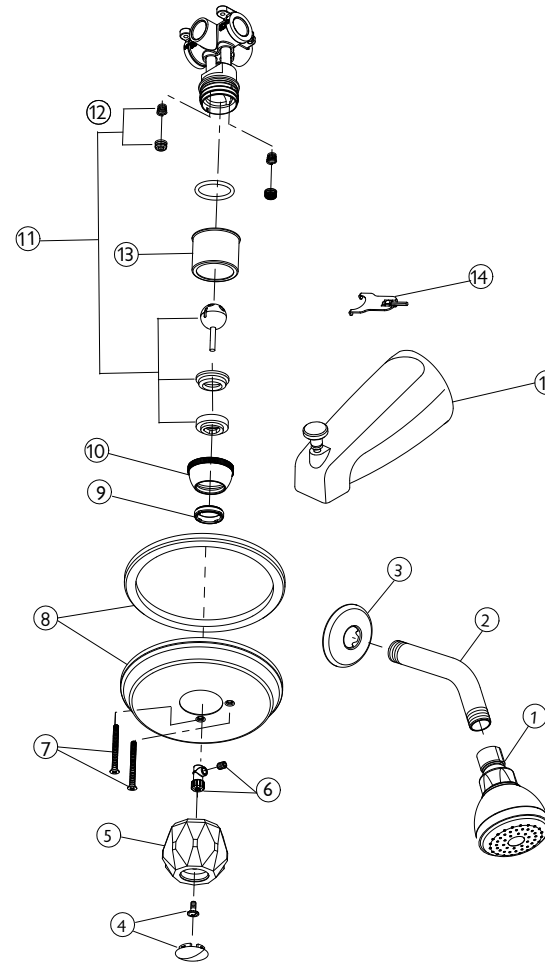

Traditional

10046_10048

Limited
LIFETIME WARRANTY
Garantía de por vida limitada



1.	Shower Head/Cabeza de ducha
2.	Shower Arm/Brazo de ducha
3.	Shower Arm Flange/ Brida del brazo de la ducha
4.	Index Button - Cold/Hot/Indicador de temperatura - frío/caliente
5.	Acrylic Handle /Manija en el acrílico
6.	Handle adaptor/Adaptador de manija
7.	Screw Set /Juego de tornillo
8.	Escutcheon Assembly/ Ensamblaje del Escudo
9.	Hex Wrench/Llave hexagonal
10.	Trim Cap/Capuchon de garniture
11.	Ball Valve Assembly/Conjunto de la válvula de bola
12.	Seat & Spring Set/Asiento y tuerca de resorte
13.	Sleeve/Manga
14.	Wrench /Llave
15.	Spout W/Diverter/Bec avec inverseur

These are general installation guidelines ONLY and are by no means comprehensive. Installation should be performed by a professional plumber.
EZ-FLO International Inc. bears no responsibility for the improper installation or misuse of this product. These are only general recommendations.

Estas son guías de instalación SOLAMENTE y por ningún motivo son exhaustivas. La instalación debe ser realizada por un plomero profesional.
EZ-FLO International, Inc. no se responsabiliza por la instalación inadecuada o mal uso de este producto. Estas son solo recomendaciones generales.

Genuine  Faucets

© 2016 EZ-FLO INTERNATIONAL, INC.
2750 E. Mission Blvd. - Ontario, California, USA 91761

Tools and supplies you will need the following to install your new faucet
Herramientas y provisiones que necesitara para instalar su nuevo grifo



adjustable wrench
llave inglesa

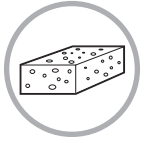

sponge or rag
esponja o trapo



clear silicone latex caulk
sellador silicona-latex
transparente



10" groove
joint pliers
pinzas de junta
ranurada 10"



cross-head
screwdriver
desarmador de
estrella



pipe joint tape
cinta adhesiva
para tubería

Before You Begin:
Turn off water supply
Remove old faucet.

Antes de Comenzar:
Cierre el suministro de agua
Quite el grifo viejo.

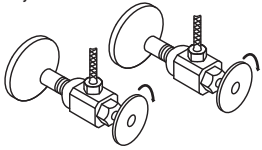

Close drain to avoid losing small parts.
Cierre el desagüe para evitar perder piezas pequeñas.

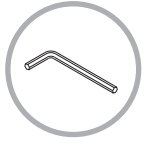

hex wrench(s)
hex wrench(s)



basin wrench
basin wrench



hacksaw
hacksaw



tube cutter
tube cutter



utility knife
utility knife



pipe wrench
pipe wrench

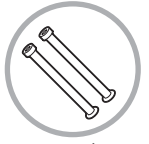

supply
supply

Installation
Instalación

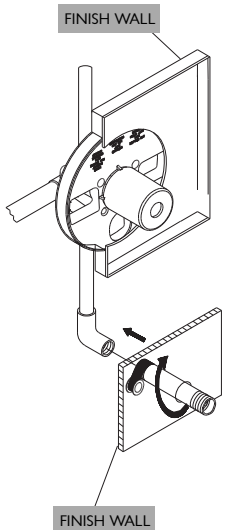

1

Install nipple for spout. Stub out pipe for installation must be at the length illustrated measured from the finished wall surface.
Para las conexiones roscadas, aplique cinta de teflón a todas las roscas de los tubos. Instale el codo en un extremo. Conecte el otro extremo al desviador de ducha.

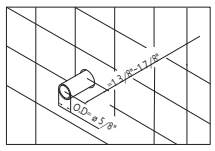

(A)

2

B. Threaded Installation with 1/2" Steel or Brass Pipe (7/8" OD): 2"
Apply pipe sealant tape on the pipe nipple threads.
B. Instalacion roscada con tubo de bronce o acero de 1/2" (7/8" diametro exterior): 2"

(B)

3

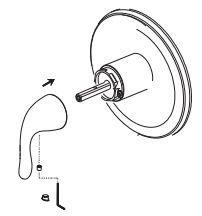

Rotate cartridge completely clockwise. Then reinstall handle in off position.
Gire el cartucho completamente en la dirección de las agujas del reloj. Reinstale la manija en la posición de

Install escutcheon onto valve using two screws. Install handle.
Instale el escudo sobre la válvula usando dos tornillos. Instale la manija.

4

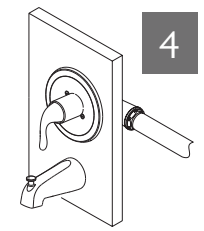

Install shower flange.
Instale la brida del brazo de ducha.

5

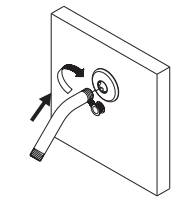

Install shower arm.
Instale el brazo de ducha.

6

Hand tighten showerhead.
Turn on water supply.
Apriete a mano la cabeza de ducha. Abra el suministro de agua.

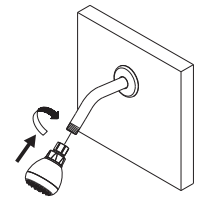

7

8

After installing faucet, turn on water to remove any left over debris and check spout for leaks.
Después de instalar el grifo, abra el suministro del agua para remover cualquier desecho que haya quedado y revise que no esté goteando el pico.

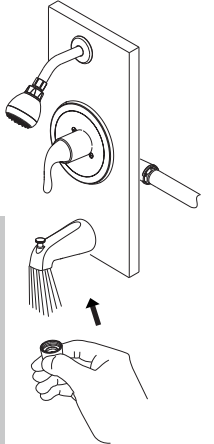

9

Repeat step 8 and pull diverter rod to check showerhead for leaks.
Repita el paso 8 y jale la varilla del desviador para revisar que no esté goteando la cabeza de ducha.

